

Vehicle Anti-Theft System Using Fingerprint Recognition Technique

Z. Brijet, B. Santhoshkumar*, N. Bharathi

Department of Computer Science, Velammal Engineering College, Chennai, India

*Corresponding author: E-Mail: ei.brijet@velammal.edu.in

ABSTRACT

Background/Objectives: This work is focused on protecting cars from unauthorized users and to prevent the vehicle from theft. Using biometric fingerprint security system only authorized persons can start the vehicle. This makes the vehicle protected.

Methods/Analysis: The security system usage is increasing and is necessary all over the world. Usage of biometrics like fingerprint is used widely and is common in factories, buildings, schools and colleges and many more applications.

Findings: This project deals with the protection of the vehicle which leads to the development of the antitheft system in a car using AT mega 328. A fingerprint sensor which is kept inside the vehicle is used to sense the fingerprint. Fingerprint sensor data reading obtained in the AT mega 328 which is analysed with the pre-assigned data. Identifying the person as the car owner or an authorized fingerprint user who can take control of the car, the engine ignition system starts. If it is an intruder, engine never starts.

Improvement: Other security systems can be hacked, whereas in this case fingerprint is being used as the key which is unique for each person and therefore gives improved security.

KEY WORDS: Fingerprint sensor, Arduino UNO board, Engine ignition system, Relay, Vehicle security system.

1. INTRODUCTION

In the 21st century, the uses of biometric based systems have seen an exponential growth. This is because of tremendous progress in this field making it possible to bring down their prices. Biometrics is becoming a new state of the art method for security systems. Biometrics are used to provide secured access to major functioning systems like ATM, cellular phones, cars, laptops, offices, and other things that need authorized access. Biometric have made significant changes in security systems making them more secure than before, efficient and cheap.

The biometric fingerprint security system is widely used. Each person's finger is different so this is more secure. The vehicle security is more important in these days. More vehicles are stolen and it cannot be found back. Security system like fingerprint system can reduce this theft, especially in cars. Fingerprint sensor and Arduino is combined together. The starting system of the vehicle is modified. The basic connection is from ignition switch that supply voltage is given to the voltage regulator then to the Arduino to turn it on and off, when input is given in fingerprint sensor it scans finger. Fingerprint match which will activate the relay that controls the starter relay. This will crank the engine. Then the fingerprint sensor will turn off. If no finger scanned or finger image do not matched then the starting system is disabled and no cranking occurs. Fingerprint sensor will not crank vehicle engine. It will only activate or deactivate starter relay to either prevent or allow cranking of engine.

In the reference paper (Froilan Destreza1, 2014), the fingerprint sensor is used to develop fingerprint based security on vehicle engine's on and off especially for motorcycles. In reference paper (Preetham, 2013), using the flash obtained and how long the flash comes based on this the vehicles distance and speed is measured. This is not used in real time functions. In reference paper (Bagavathy, 2011), the ARM processor is used to control the engine starting system. It only prevents the vehicle from theft and cannot find the thief. It uses sensors like fingerprint sensor, door sensor. It uses face recognition to identify the person who is trying to start the vehicle. In (Karthikeyan, 2012), the fingerprint sensor is used with microcontroller to verify whether the person is already existing one or new one and shows the result in LCD display. The sensor used is Fingerprint module 3030 developed by NITGEN. Microcontroller used here is AT89c52 model. It is a CMOS 8 bit microcontroller type.

In this paper the function is to design a fingerprint-based engine starter to upgrade and to develop higher security in a vehicle especially in cars. The vehicle ignition system is controlled using Arduino UNO board with a fingerprint sensor the person fingerprint is identified and find whether the person is authorized person or not. Only an authorized person can start the vehicle otherwise the vehicle does not start. This controller is used because of low cost, high performance and small in size. By attaching the module in the ignition system of vehicle theft of the vehicle is prevented.

Vehicle Ignition System: The vehicle engine ignition system is shown in Figure.1. It consists of battery, fuse, ignition switch, relay, neutral safety switch, solenoid, starter motor. The purpose of the ignition system is to start the starter coil in crank shaft and generate a very high voltage from the battery of vehicle and sends it to each sparkplug which in turn ignites the fuel-air mixture in the engine's fuel combustion chambers.

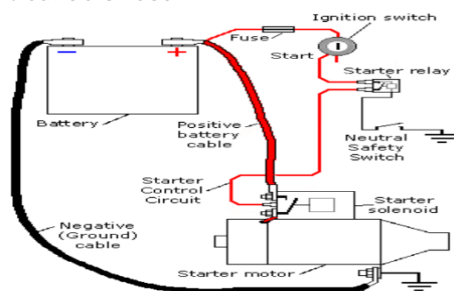

Figure.1. Starting system of electronic ignition

The mechanical system uses breaker points to interrupt their low voltage, high current function through the primary winding of the coil on the mechanical system will be exposed to mechanical wear form where they ride the internal combustion engine's camshaft to open and close (Shui, 2006), as well as oxidation and burning occurs at the contact surfaces from the constant sparking occurs at the internal combustion engine. They need regular functioning to compensate for wear, which is responsible for spark timing, is subject to mechanical variations in internal combustion engines. Also the spark voltage depends on contact effectiveness, and poor sparking which can lead to lower engine efficiency and therefore reduces the engine's performance. By comparison with the electrical system, a mechanical contact breaker system has no control over an average ignition current of greater than 3A while still giving a reasonable service to engine's life, and this may limit the power of the spark in ignition and ultimate engine's speed and therefore Electronic Ignition (EI) solves these problems.

Digital electronic ignition system (Froilan Destreza1, 2014) is available for small engines from 100mm to 10000mm. This ignition system is made possible by using low cost, high speed, high efficiency performance, and small footprint function of vehicle ignition. The Figure.2, shows the block diagram of vehicle anti-theft system using fingerprint recognition technique.

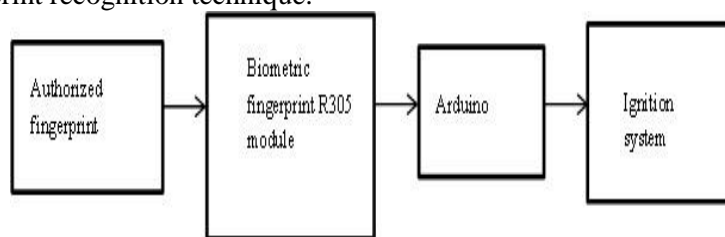

Figure.2. Block diagram of vehicle anti-theft system

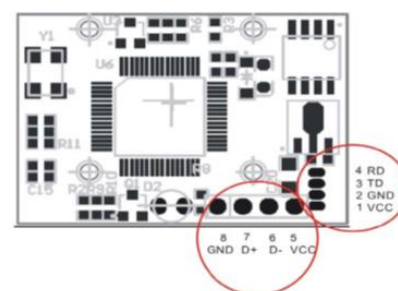

Figure.3. R305 Fingerprint module

In this above anti-theft system the R305 fingerprint module is used. The fingerprint module connection is shown in Figure.3. Fingerprint processing includes two parts. They are fingerprint enrolment and fingerprint matching (the matching can be 1:1 or 1:N type). For 1:1 matching type, system will compare the finger which is enrolled with templates stored in the Module; for 1:N matching type, system will search the total library file for the matching finger. In both types, system will return the matching result, success or failure. In this project work 1:N type is used.

Table.1. Fingerprint sensor serial communication pin configuration

Pin number	Name	Function description
1	Vin	Power input
2	GND	Signal ground
3	TD	Data output. TTL logic level
4	RD	Data input. TTL logic level
5	VCC	+5V DC
6	D-	Data-
7	D+	Data+
8	GND	Ground

There are eight pin connections in the fingerprint sensor. These pin connection are explained in the Table.1. Fingerprint sensor built inside the R305 fingerprint module scans the finger and verifies with the pre-loaded data and shows the result whether it is matched or not. The R305 fingerprint module is connected and gives the data to the Arduino board. If the result matches then it made the relay to supply voltage. If it is not matched then the relay is low, the supply has been stopped to the unit. The parameter shown in the above Table.1, is used to control the UART communication (Preetham, 2013), speed of the module. Corresponding baud rate is $9600 \times N$ bps. N value is an integer, where $N=[1,12]$. The default baud rate is 57600bps. Baud rate can be varied between $9600 \sim 115200$ bps.

Power input to the fingerprint module is DC 3.6V-6.0V. Working current of fingerprint sensor for typical current it is: 100mA and for peak current it is: 150mA. For each different fingerprint separate ID is given. Enroll can be done with the help of switch or it can be previously stored when loading the program to the Arduino UNO board using the Arduino IDE software. To verify the authorized person fingerprint there is a button for verify if the fingerprint scanned is an authorized one then relay becomes high and then engine starts otherwise the engine will not start.

Microcontroller Interface: The Arduino Uno is a microcontroller board (Ruchita Shah, 2012), based on the ATmega328. The Uno board functioning is different from all other boards in that it does not use the FTDI USB to serial driver chip. Instead, the ATmega328 is programmed as a USB to serial converter. The ATmega328 is a low power CMOS 8 bit microcontroller based on the AVR enhanced RISC architecture structure. The interfacing of microcontroller and ignition system is shown in Figure.4.

The fingerprints of only the authorized persons are enrolled for further verification into the microcontroller. The microcontroller controls the fingerprint sensor when an authorized person is scanned it allows the relay to contact and supply power to ignition system (Bagavathy, 2011). Then the engine can be turned on. If an unauthorized person is scanned it does not make the relay to turn on. So, no current flows to the engine ignition system and it cannot be turned on. The system with ignition system and the hardware component connection is shown in Figure.4.

The technical specification of microcontroller board gives the operating functions of Arduino UNO board.

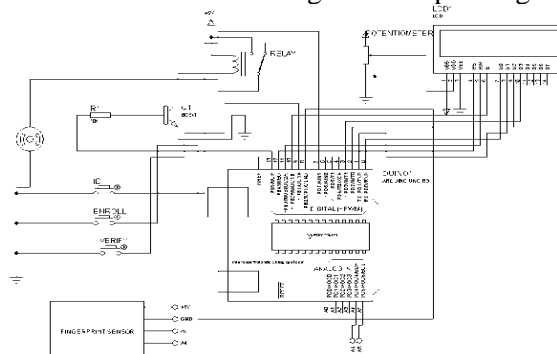

Figure.4. Interface between ignition system and microcontroller

Microcontroller type	: ATmega328
Operating Voltage of Arduino	: 5V
Supply Voltage for the board	: 7-12V
Maximum supply voltage (not rec)	: 20V
Digital I/O Pin11	: 14
Analog Input Pins	: 6
DC Current per I/O Pin	: 40 mA
DC Current for 3.3V Pin in board	: 50 mA
Flash Memory of microcontroller	: 32 KB
SRAM	: 2 KB
EEPROM of Arduino UNO	: 1 KB
Clock Speed of Arduino	: 16 MHz

Fingerprint Module Connected to the Engine Starting System: The hardware connection setup is shown in Figure.5. In this relay8 connected with the biometric finger print scanner is added to the ignition line and battery of engine starting system. A relay switch is used to control the power supply from microcontroller to vehicle ignition system. A relay switch is an electrical switch that acts as either a power source or a ground in an electrical circuit. When coil is energized the common terminal and NO terminal have continuity. Anytime the device can be crank to switch on/off a device which draws more current with high voltage.

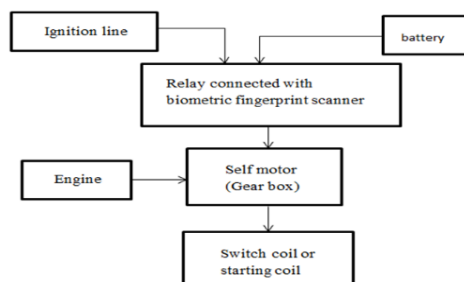

Figure.5. Engine system with hardware connected to the vehicle engine starting system

The electric engine system has starter motor that is connected with the ignition switch also a supply from battery is given to the electric engine¹⁰. When key is inserted the circuit closes and gives supply to starter motor and it cranks the engine.

The fingerprint security system is placed here to control the engine ignition system. Power supply is given through regulated power supply board for the microcontroller. This system is connected to the battery of the vehicle. So it draws current supply from battery to the fingerprint sensor. Digital switch used to control high voltage and current than normal board does. When input logic voltage relay will switch to allow current to flow or cut off depending on wiring (Narendar Singh, 2013).

When this relay is activated by giving authorized person's fingerprint as an input the engine is turned on by the starting coil. When the ignition is given, the self-motor starts to rotate and makes the switch coil to rotate. The Bendix gear grabs the switch coil or starting coil after this process and the engine of the vehicle starts. When the engine turns on, the crank shaft begins to rotate continuously.

In Arduino Uno IDE software write the entire code and load the program to the Arduino board (Brian Evans, 2007). After that the fingerprint sensor is connected and ready for enrolment, which is used for authentication purpose. Each person save their fingerprint in different address in fingerprint sensor. This total model is fixed in the car and when authorized person scans their finger the vehicle's engine starts.

2. RESULTS

Both for authorized and unauthorized persons fingerprint the outputs are obtained. The Arduino board is connected to the microcontroller. When a finger is placed over the fingerprint sensor it scans and compares with pre-loaded data and if the fingerprint matches then the ignition system can be turned on, if the fingerprint does not matches then the ignition system cannot be turned on.

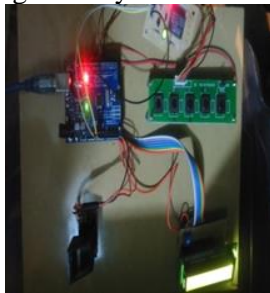

Figure.6. Authorized person fingerprint is scanned and the engine turned on

Figure.6, shows when fingerprint matches, that is authorized person input is given the Arduino controller makes the relay to turn on which leads to turn on the engine of vehicles.

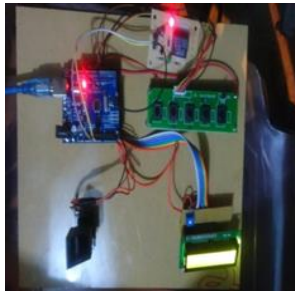

Figure.7. Unauthorized person fingerprint is scanned and the engine remains off

Figure.7, shows when fingerprint does not match, that is unauthorized person input is given the Arduino controller does not perform its action and the relay kept in off state. So there is no current flow to the ignition system and the engine remains in off state.

3. CONCLUSION

Thus, the vehicle's engine cranking system is secured by interfacing Arduino UNO board, fingerprint sensor and relay which collectively forms the anti-theft system and provides better protection from unauthorized persons

REFERENCES

Bagavathy P, Dhaya R, Devakumar T, Proc. Real Time Car Theft Decline System Using ARM Processor, Int. Conf. on Advances in Recent Technologies in Communication and Computing, 2011.

BalajeeSeshasayee V and Manikandan E, Automobile Security System Based on Face Recognition Structure Using GSM Network, Advance in Electronic and Electric Engineering, 3 (6), 2013.

Brian Evans W, Arduino Programming Notebook, First Edition, 2007.

Froilan Destreza I G, Antonio Nepomuceno P, Christopher Drio C, Jr. Development of Fingerprint Engine Starter, Computer Engineering and Intelligent Systems, 5 (1), 2014.

Karthikeyan A, Sowndharya J, Fingerprint Based Ignition System, International Journal of Computational Engineering Research, 2 (2), 2012.

Narendar Singh D and Tejaswi K, Real Time Vehicle Theft Identity and Control System Based on ARM 9, International Journal of Latest Trends in Engineering and Technology (IJLTET), 2 (1), 2013.

Omidiora E.O, A Prototype of a Fingerprint Based Ignition Systems in Vehicles, European Journal of Scientific Research, Euro Journals Publishing, Inc, 62 (2), 2011, 164-171,

Preetham S, Sanath S, Sreevatsa G S, Sumanth M, Varun P M, Krishna Kumar D.N, Smart Console for Vehicles, Texas Instruments India Educators' Conference, 2013.

Ruchita Shah J and Anuradha Gharge P, GSM Based Car Security System, International Journal of Engineering and Innovative Technology (IJEIT), 2 (4), 2012.

Shui YU, Liguang LI, and Guangyu DONG and Xusheng ZHANG, A Study of Control Strategies of PFI Engine during Cranking and Start for HEVs, 2006.